



Vanteriors

The Leader in Work Vehicle Modifications

1093 Lorimar Drive, Mississauga, ON L5S 1M5 Tel: (905) 565-0540 or (800) 668-7942 Fax: (905) 565-0545

Heavy Duty Aluminum Ladder Rack Assemblies

VR3066, VR3067, VR3068

for all Full Size Vans, G.M.C., Dodge and Ford

VR3066 Single 6 ft. Griplock Rack,
Passenger or Street Side.
Optional **VR3101** Adapter
Utility Kit

OR

VR3067 Single 7 ft. Griplock Rack,
Passenger or Street Side.
Optional **VR3101** Adapter
Utility Kit

OR

VR3068 Single 8 ft. Griplock Rack,
Passenger or Street Side.
Optional **VR3101** Adapter
Utility Kit

VR3066 Single 6 ft. Griplock Rack,
Passenger or Street side.
Optional **VR3116** Adapter
Griplock Kit

OR

VR3067 Single 7 ft. Griplock Rack,
Passenger or Street side.
Optional **VR3117** Adapter
Griplock Kit

OR

VR3068 Single 8 ft. Griplock Rack,
Passenger or Street side.
Optional **VR3118** Adapter
Griplock Kit

VR3066 Single 6 ft. Griplock Rack,
Passenger or Street side.
Optional **VR3126** Step
Ladder Guide 6'

OR

VR3067 Single 7 ft. Griplock Rack,
Passenger or Street side.
Optional **VR3127** Step
Ladder Guide 7'

OR

VR3068 Single 8 ft. Griplock Rack,
Passenger or Street side
Optional **VR3128** Step
Ladder Guide 8'

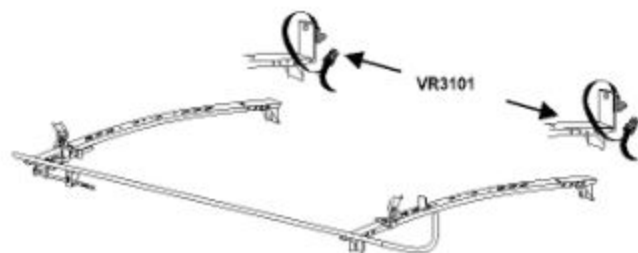

General Instructions

The quantity of each part will be shown under the part number for the ladder rack ordered. Unpack the box of ladder rack parts and check the contents against the list of materials shown on page 3.

Please notify us immediately if anything is missing.

OUR WARRANTY:

“VanTeriors warrants its own products from defects in manufacture and material under normal use and service for a period of five years from the date of invoice. All other products are subject to the individual manufacturer’s own warranty.”



FOR HELP:

“If you have a problem following these instructions please call us at (800) 668-7942 ask for the Engineering Department.”

Assembly & Installation Procedure

Full size Vans

Exploded View of VR3066, VR3067 & VR3068

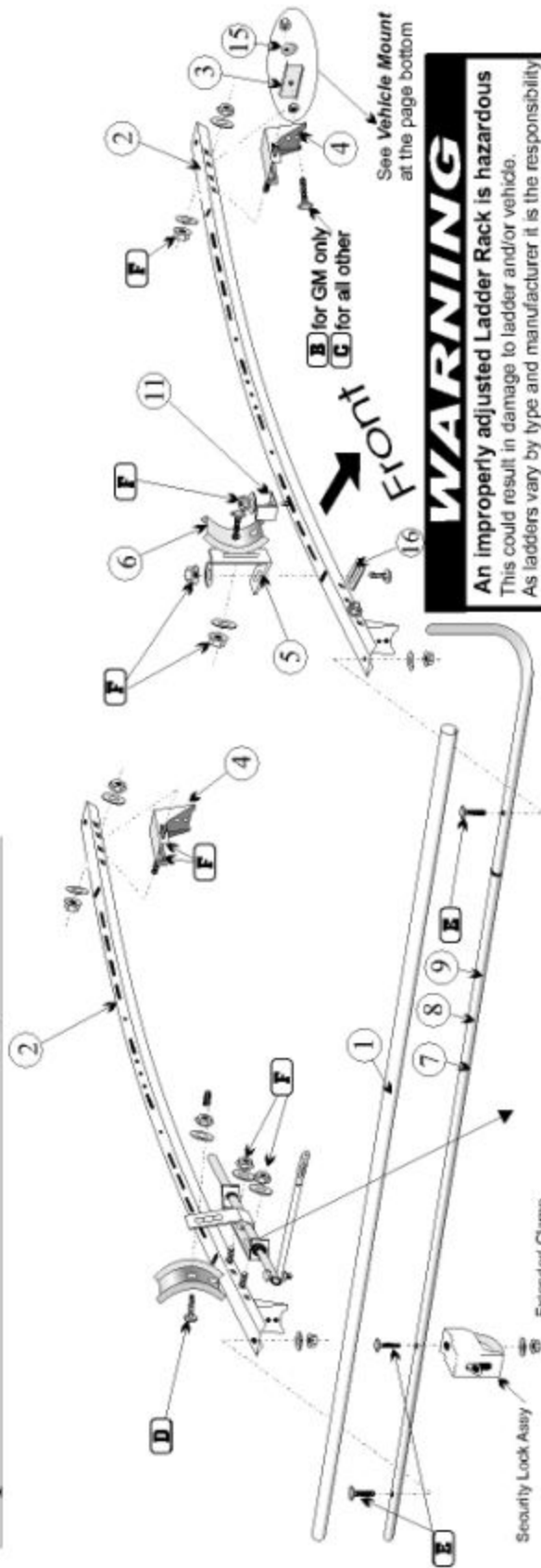

WARNING

An improperly adjusted Ladder Rack is hazardous
 This could result in damage to ladder and/or vehicle.
 As ladders vary by type and manufacturer it is the responsibility
 of the end user to adjust rack for his/her specific requirements.
 See page 9 for instructions.

ITEM	DESCRIPTION	VR3066	VR3067	VR3068
1	PVC Wearguard	1	1	1
2	Cross Support 72" Bow	2	2	2
3	Foot Clamp	4	4	4
4	Foot Channel 5.75"	4	4	4
5	Adjustable Stop Post	1	1	1
6	Extended Clamp Bracket	1	1	1
7	Outer Rail 6"	1	1	1
8	Outer Rail 7"			
9	Outer Rail 8"	1	1	1
10	Universal Locking Assy.	1	1	1
11	Stop Slider	1	1	1
15	Adjustable Cam Nut	1	1	1
16	Stiffener Stainless Steel	1	1	1

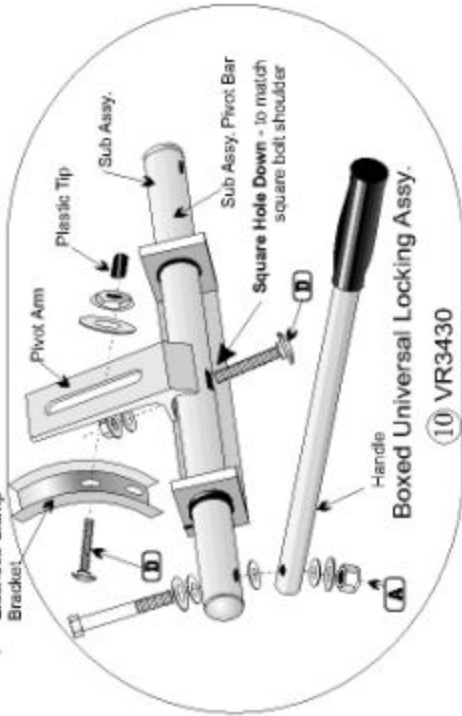

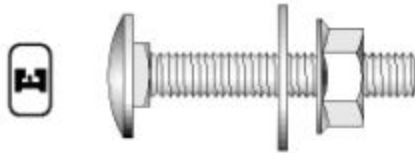
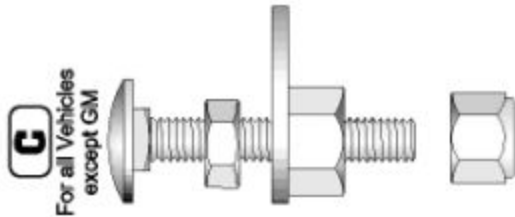
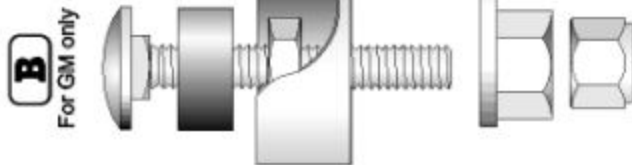
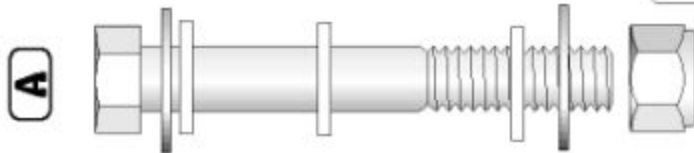

**DO NOT EXCEED 20 FT/LBS TORQUE
WHEN TIGHTENING 3/8-16 HARDWARE**

GROUP	SIZE	DESCRIPTION
A	7/16-14 x 3"	H/H Bolt, 2 Plain Washers, 3 Nylon Washers, Nylon Lock
B	3/8-16 x 2"	Carriage Bolt, Jam Nut, 5/8" Spacer, Cam Nut & Nylon Lock-nut
C	3/8-16 x 1-3/4"	Carriage Bolt, Jam Nut, Cam Nut & Nylon Lock-nut
D	3/8-16 x 2"	Carriage Bolt, Plain Washer, Hex Flange Nut
E	3/8-16 x 1-3/4"	Carriage Bolt, Plain Washer, & Hex Flange Nut
F	3/8-16 x 1-1/4"	Carriage Bolt, Plain Washer, & Hex Flange Nut

Vehicle Mount

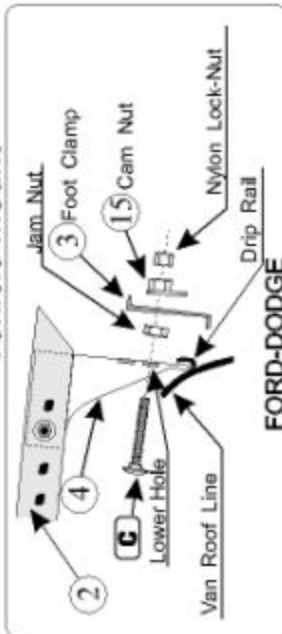

FORD-DODGE

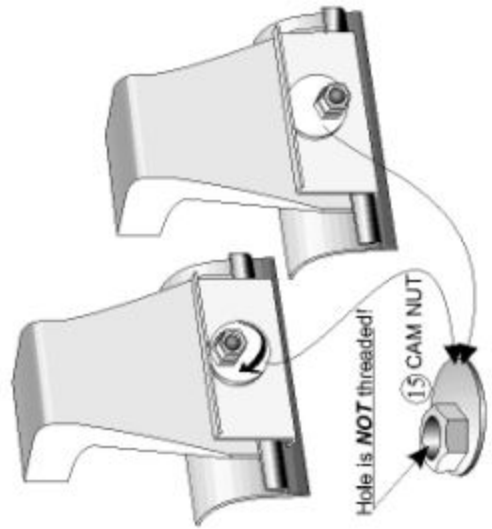
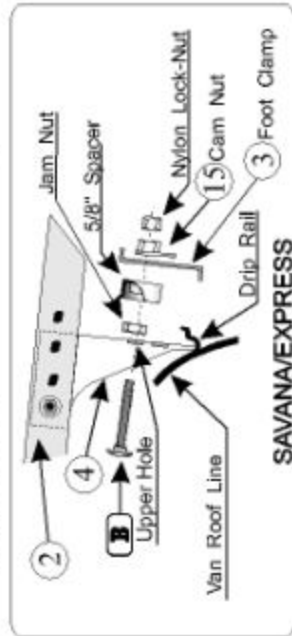

Assembly & Installation Procedure

Full size Vans

COMPONENTS LIST

ITEM	PART No.	DESCRIPTION	VR3066	VR3067	VR3068
①	VR0300	PVC WEARGUARD	1	1	1
②	VR2002	CROSS SUPPORT 72" BOW	2	2	2
③	VR3301	FOOT CLAMP	4	4	4
④	VR2015	FOOT CHANNEL 5.75"	4	4	4
⑤	VR3302	ADJUSTABLE STOP POST	1	1	1
⑥	VR3303	EXTENDED CLAMP BRACKET	1	1	1
⑦	VR3306	OUTER RAIL 6'	1		
⑧	VR3307	OUTER RAIL 7'		1	
⑨	VR3308	OUTER RAIL 8'			1
⑩	VR3430	UNIVERSAL LOCKING ASSY.	1	1	1
⑪	VR2256	STOP SLIDER	1	1	1
⑫	VR2174	STIFFENER STAINLESS STEEL	1	1	1
	VR3440	HARDWARE (for FOOT F/S)	1	1	1
	VR3441	HARDWARE (for FOOT EX/SAVANA)	1	1	1
	VR3450	HARDWARE (for UN.LK. ASSY)	1	1	1
	VR3460	HARDWARE (for ST. CLAMPS)	1	1	1

Full Size 6' Ladder Rack

Full Size 7' Ladder Rack

Full Size 8' Ladder Rack

INSTALLATION HARDWARE

ITEM	HARDWARE DESCRIPTION	VR3440	VR3441	VR3450	VR3460
	(VR0302) Hardw Plug White 1" DIA				1
	(VR0303) Tip Plastic .313 x 3/4"			1	
⑬	(VR2071) Adjustable Cam Nut	4			
	(VR2154) 3/8-16 x 1-3/4" Carriage Bolt	4		1	2
	(VR2161) 3/8-16 x 1-1/4" Carriage Bolt	8		1	4
	(VR2162) 3/8-16 x 2" Carriage Bolt		4	2	
	(VR2163) 3/8-16 Hex Flanged Nut	8		4	6
	(VR2164) 3/8-16 Nylon Lock-Nut	4			
	(VR2165) 7/16" Blank Washer	8		6	6
	(VR2166) 7/16-14 X 3" H.H. Bolt Gr5			1	
	(VR2167) 7/16-14 Nylon Lock-nut			1	
	(VR2168) Washer 7/16 Nylon			3	
	(VR2171) Spacer 5/8" Thick		4		
	(VR2173) 3/8-16 Jam Nut	4			

HD for FOOT F/S

HD for FOOT Ex/Savana

HD for UN.LK. Assy

HD for ST. Clamps

FASTENING GROUPS

GROUP	REMARKS	SIZE	DESCRIPTION
(A)		7/16-14 x 3"	H.H. Bolt, 2 Plain Washers, 3 Nylon Washers, Nylon Lock
(B)	For GM only	3/8-16 x 2"	Carriage Bolt, 5/8" Spacer, Jam Nut, Cam Nut & Nylon Lock-nut
(C)	For all Vehicles but GM	3/8-16 x 1-3/4"	Carriage Bolt, Jam Nut, Cam Nut & Nylon Lock-nut
(D)		3/8-16 x 2"	Carriage Bolt, Plain Washer, Hex Flange Nut & Plastic Tip
(E)		3/8-16 x 1-3/4"	Carriage Bolt, Plain Washer, & Hex Flange Nut
(F)		3/8-16 x 1-1/4"	Carriage Bolt, Plain Washer, & Hex Flange Nut

Assembly & Installation Procedure

Full Size Vans

Tools Required

5/8" Open end wrench (2), 9/16" Open end wrench

DO NOT EXCEED 20 FT/LBS TORQUE WHEN TIGHTENING 3/8-16 HARDWARE

Assembly

Step 1: Front Cross Support Sub-Assembly

- 1.1 Attach a Foot Channel (4) to the sq. holes at each end of the Cross Support Bow (2) using two (2) of fas. Group (F). See Fig 1.1 for assistance. The bolt heads should be inside the channel, allowing access to the nuts for tightening at a later time.

Note: For all vehicles except Savana/Express use outer Sq. Holes in Cross Support Bow. For Savana/Express use inner Sq. Holes.

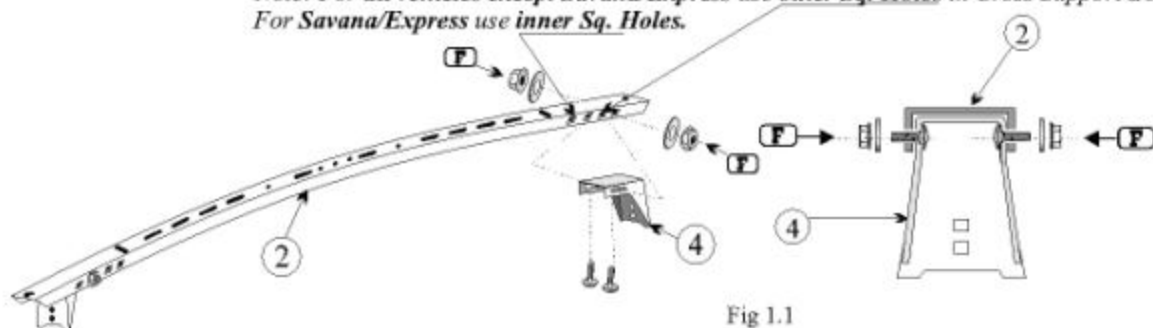

Fig 1.1

- 1.2 Attach the Adj. Stop Post (5) to the Cross Support Channel using fas. Group (F) and Stiffener Stainless Steel (16) underneath Support Channel. Place it between the nibs on top of the Channel with upright portion to the front. Attach an Extended Clamp Bracket (6) to the Stop Post (5) using fas. Group (F).
- 1.3 Attach Stop Slider (11) to the Cross Support Bow (2) using Fas. Group (F)

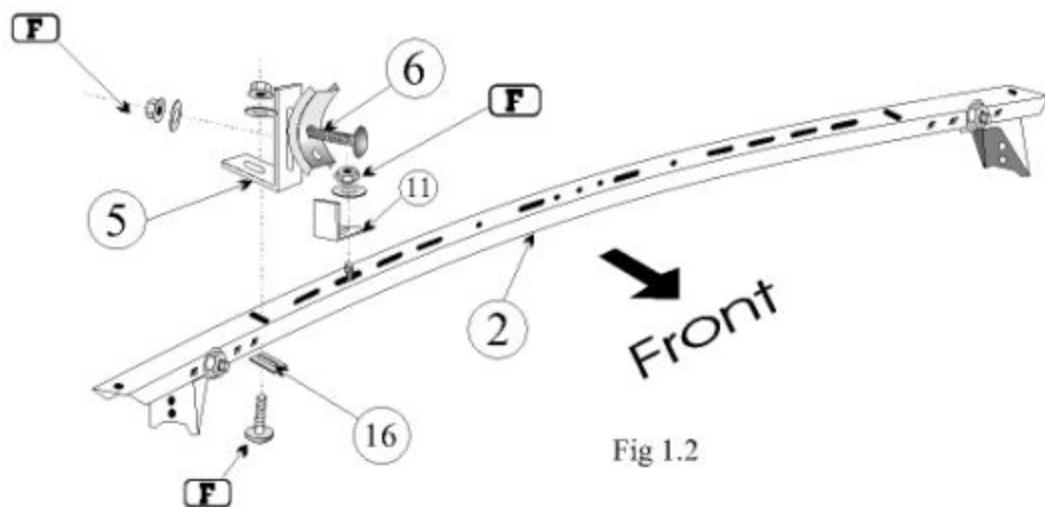

Fig 1.2

Assembly & Installation Procedure

Full Size Vans

Step 2: Passenger/Drive Side Locking Assembly (Passenger Side Shown)

Using the figure below, as your guide for the handle attachment. *(Be sure the two (2) slots on the Torsion Bracket are offset toward the top).* Attach the Pivot Handle as shown (Passenger Side Assembly) with fas. Group **A**. (For the street side assembly, Handle is on the opposite end). Tighten to allow frictioned movement of the handle. *(Do not over tighten).* Attach the Pivot Arm with fas. Group **D** (square hole on Sub Assy axis should be down).

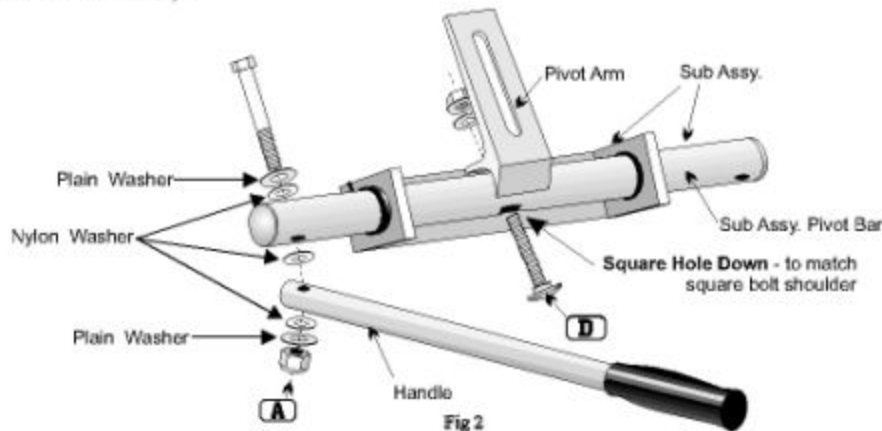

Step 3: Rear Cross Support Sub-Assembly

- 3.1 Attach a Foot Channel **4** to the two (2) slots at each end of the Cross Support Bow **2** using two (2) of fas. Group **F**. The bolt heads should be inside the channel, allowing ease to the nuts for tightening at a later time.

*Note: For all vehicles except Savana/Express use outer sq. Holes in Cross Support Bow **2**.
For Savana/Express use inner sq. Holes. See Fig 1.1.*

- 3.2 Attach the Universal Locking Assembly/Assemblies to the front of the Cross Support Bow **2** using the Foot Channel Mounting bolts aligned through the two (2) slots in the Universal Locking Assembly.
- 3.3 Attach an Extended Clamp Bracket **6** to the upright post of the Locking Assembly with fas. Group **D**. Push the Plastic Tip **14** over the end of the bolt.

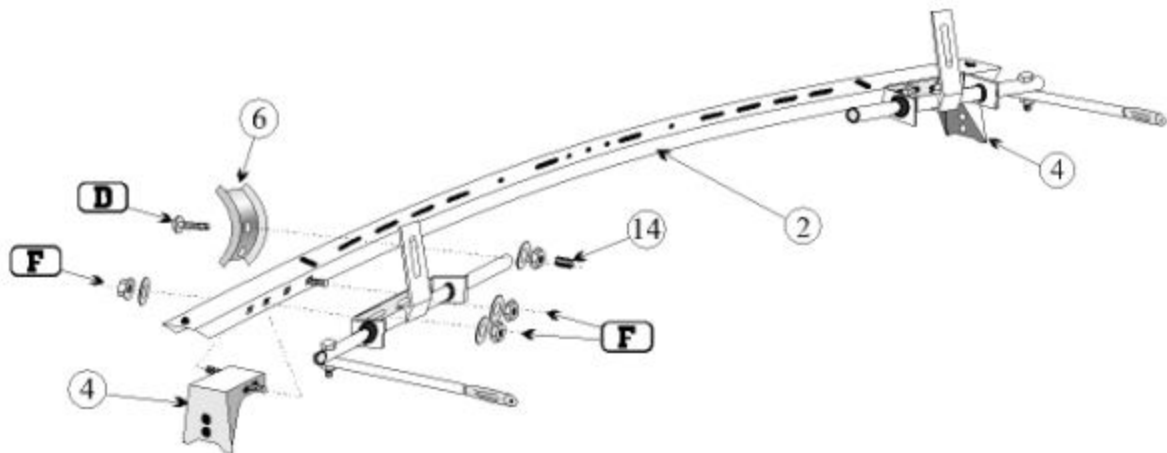

Assembly & Installation Procedure

Full Size Vans

Step4: Outer Rail Assembly.

- 4.1 Insert Rail Hook into Rail using a slight twisting motion evenly.
- 4.2 Make sure First Sq. Hole of Rail Hook is seating on the Center Line of the assembled Outer Rail. See Fig.4.

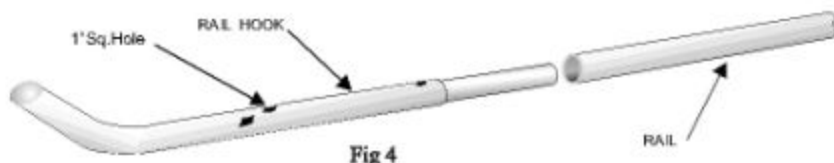

Step 5: Security Lock Sub-Assembly

Outer Rail has two sets of 3 holes shifted 1" and 30 degrees to provide outside tilt for the Rails on both passenger and driver's sides. See diagram to choose appropriate set of holes.

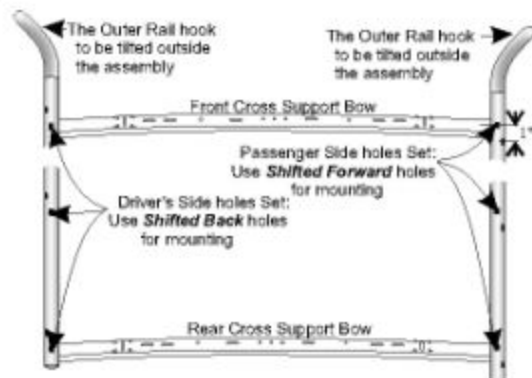

- 5.1 Place 1-3/4" carriage bolts from Fas.group **E** into available holes in Outer Rail.
- 5.2 Attach the Security Lock Assembly to the Outer Rail with fas. Group **E** (See the figure below for assistance).
- 5.3 Trim PVC Wearguard **1** to fit over the Outer Rail and install.

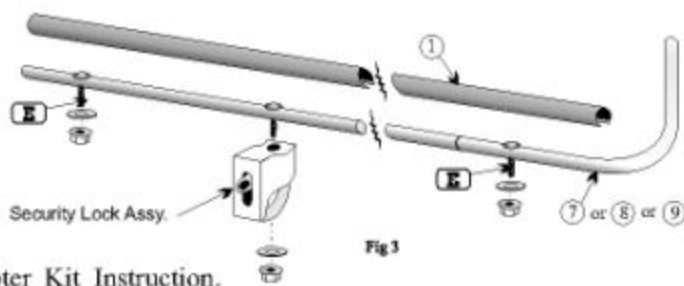

Options: VR3101

See Utility Adapter Kit Instruction.

Options: VR3116, VR3117, VR3118

See Adapter Griplock Kit Instruction.

Options: VR3126, VR3127, VR3128

See Instruction for Step Ladder Guide Assembly.

Assembly & Installation Procedure

Full Size Vans

Installation:

Step 1: Mounting Rear Cross Support

- 1.1 Position the rear Cross Support subassembly atop the rear of the van. The feet should be just forward of the seam in the drip rail. Extend the feet to the outside of the drip rail channel. Take precautions not to damage the roof.

For All Vehicles except GM Savana/Express:

- 1.2 Centre the Cross Support on the feet. Using fas. Group **C** place a bolt through the lower square hole at the bottom of the Foot Channel **4**. Put (1) Jam Nut over the bolt, then place a Foot Clamp **3** over the bolt and under the drip rail.
- 1.3 Add the Adjustable Cam Nut **15** and the nylon locknut. Use 5/8" open end wrenches to rotate the Adjustable Cam Nut, which will tighten the Foot Clamp under the Drip Rail. Secure the Adjustable Cam Nut by tightening the nylon locknut. This procedure applies to all the ladder rack feet.

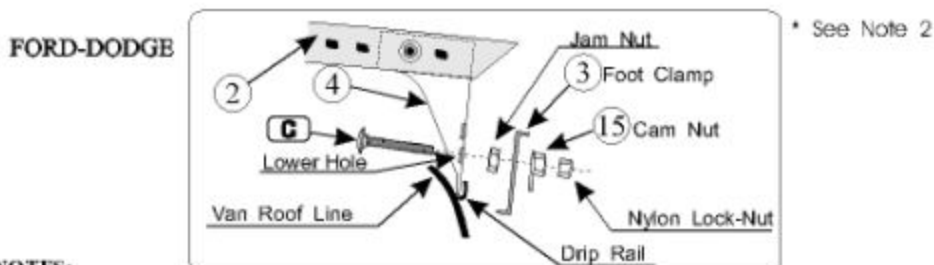

NOTES:

1. On Dodge 109" WB Vans with sliding side cargo doors, it is necessary to remove and notch the sliding door weather guard to permit gripping under the drip rail.

- *2. Above side cargo door it may be necessary to add additional washers to shim foot clamp out providing additional clearance for door. In some cases it may be necessary to adjust height of swing door.

For GM Savana/Express Only:

- 1.2 Centre the Cross Support on the feet. Using fas. Group **B** place a bolt through the upper square hole at the bottom of the Foot Channel **4**. Place Jam Nut and 5/8" Spacer over the bolt, then place a Foot Clamp **3** over the bolt and under the drip rail.
- 1.3 Add the Adjustable Cam Nut **15** and the nylon locknut. Use 5/8" open end wrenches to rotate the Adjustable Cam Nut, which will tighten the Foot Clamp under the Drip Rail. Secure the Adjustable Cam Nut by tightening the nylon locknut. This procedure applies to all the ladder rack feet.

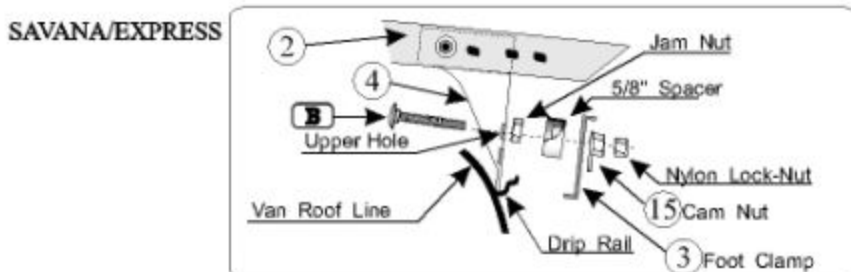

Assembly & Installation Procedure

Full Size Vans

Step 2: Mounting Front Cross Support

- 2.1 Position the front Cross Support sub-assembly on top of the van 6', 7', or 8' (depending on choice of outer rail) forward of the rear Cross Support. Take precautions not to damage the roof. Mount Outer Rail so the hooked end is toward the front of the van. Use fas. Group **E** to mount each Outer Rail through the holes in the ends of the Cross Support.
- 2.2 Centre the Cross Support on the feet. Using fas. Group **G** place a bolt through the square hole at the bottom of the Foot Channel **4** . Place (1) 1/2" washer over the bolt, then place a Foot Clamp **3** over the bolt and under the drip rail.
- 2.3 Add the Adjustable Cam Nut **15** and the nylon locknut. Use 5/8" open end wrenches to rotate the Adjustable Cam Nut, which will tighten the Foot Clamp under the Drip Rail. Secure the Adjustable Cam Nut by tightening the nylon locknut. This procedure applies to all the ladder rack feet.

Step 3: Final Assembly

- 3.1 Recheck the tightness of all Outer Rail(s) fasteners.
- 3.2 With the locking handle in it's latched position, adjust, if necessary, the Locking Bracket Assembly so the locking handle is PARALLEL to the Outer Rail.
- 3.3 Tighten all fasteners for Foot Channels to Cross Support Channel, including the additional fastener group used to complete the attachment of the Locking Bracket Assembly(s) to the Cross Support Channel.
- 3.4 If no ladder is installed at this time check all other fasteners for tightness.

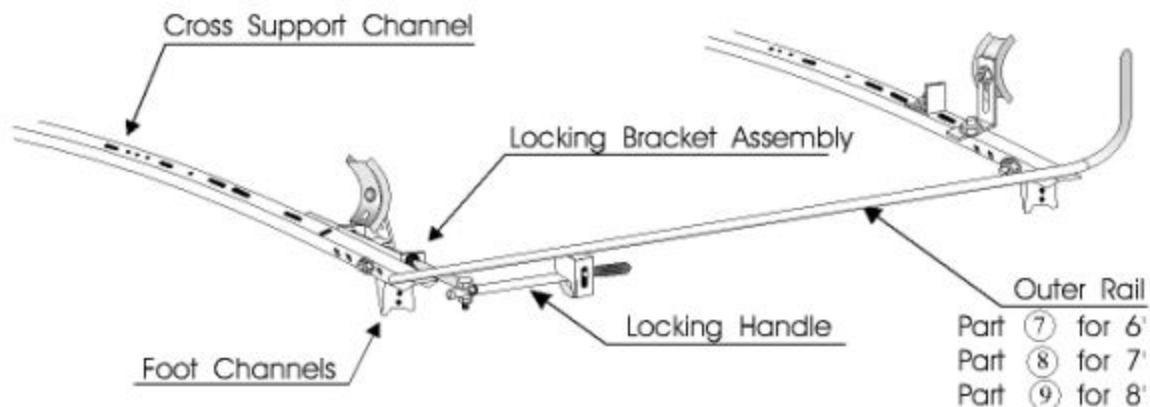

Adjusting Ladder Rack for Ladder

WARNING

An improperly adjusted Ladder Rack is hazardous

This could result in damage to ladder and/or vehicle.

As ladders vary by type and manufacturer it is the responsibility of the end user to adjust rack for his/her specific requirements.

- Step 1:** Loosen fasteners marked **(A)**, **(B)** and **(C)** on drawing below. Release Locking Handle and load your ladder into desired position.
- Step 2:** Place Locking Handle in Latch as shown. Adjust the height of the Extended Clamp Brackets so that they cradle the ladder rungs with a slight downward pressure. Do this on both front and rear cross supports then tighten fasteners **(A)**.
- Step 3:** To adjust the latching tension: release Locking Handle from Latch and allow Handle Grip to rest in the drip rail on full size vans or on roof panel on mini vans. Shift ladder forward against Rear Extended Clamp Bracket. Slide front Adjustable Stop Post so Front Extended Clamp Bracket is against rung. Tighten fastener **(B)**. Latch Locking Handle, there should be noticeable tension.
- Step 4:** With ladder snug against outer rail, move Stop Slider against ladder rail and tighten **(C)** fastener.

Your ladder rack is now adjusted to safely carry your ladder. If the ladder is changed, be sure to adjust your ladder rack accordingly.

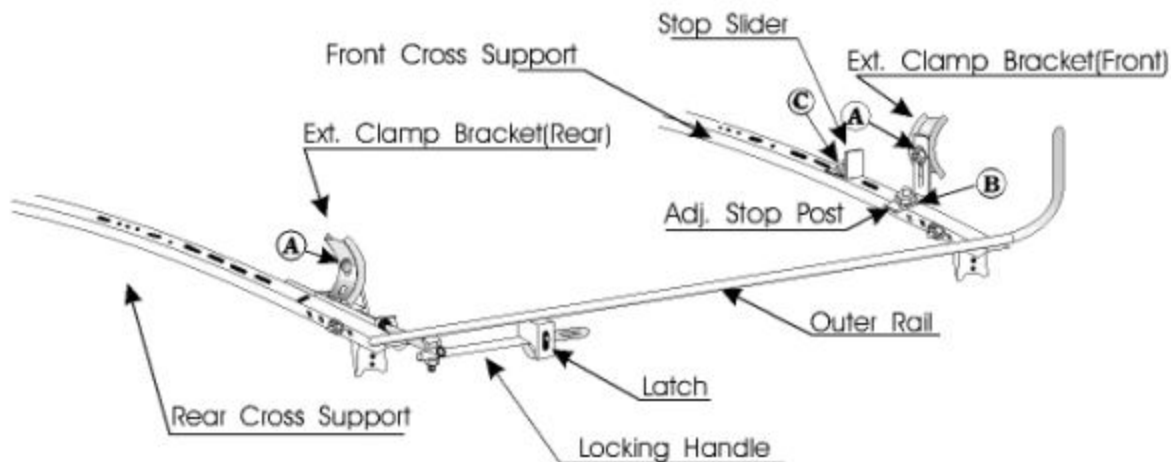

Note to Installer:

Please send this page with the Vehicle so end user can properly adjust the rack to His/Her ladder.
Thank You

Ajustement du support à échelle

Avertissement

Un support à échelle mal ajusté peut être hasardeux et aurait pour conséquence d'endommager soit l'échelle ou le véhicule.

Vu que les dimensions des échelles varient d'un manufacturier à l'autre, il est du devoir de l'utilisateur d'ajuster son support selon le type d'échelle.

- Etape no. 1** Desserrer les écrous en (A), (B), et (C) indiqués sur le diagramme ci-dessous. Abaisser la poignée latérale du support et embarquer l'échelle à la position voulue.
- Etape no. 2** Avec la poignée latérale en position fermée (ou barrée), ajuster premièrement la hauteur des attaches extensibles (enduites de caoutchouc) pour qu'elles puissent s'appuyer sur les barreaux de l'échelle avec une légère pression vers le bas. Faites ceci sur celui d'en avant et d'en arrière et resserrer les écrous en (A).
- Etape no. 3** Pour ajuster la tension, sortir la poignée latérale du loquet et laisser reposer le bout de cette dernière sur la gouttière du camion (pour les fourgonnettes pleine grandeur) ou sur le toit dans le cas de mini-fourgonnettes. Avancer l'échelle vers l'avant en appuyant le barreau de l'échelle sur le montant réglable d'arrêt situé sur la traverse arrière. Glisser le montant réglable d'arrêt situé à l'avant pour que l'attache extensible accote sur le barreau de l'échelle. Serrer l'écrou en (B). Remettre la poignée latérale dans le loquet la tension devrait être acceptable.
- Etape no. 4** Avec l'échelle appuyée sur la barre longitudinale, diriger le montant d'arrêt (C) vers l'échelle et serrer l'écrou.

Votre support est maintenant ajusté pour transporter votre échelle de façon sécuritaire. Si vous changez de type d'échelle, ajuster en conséquence.

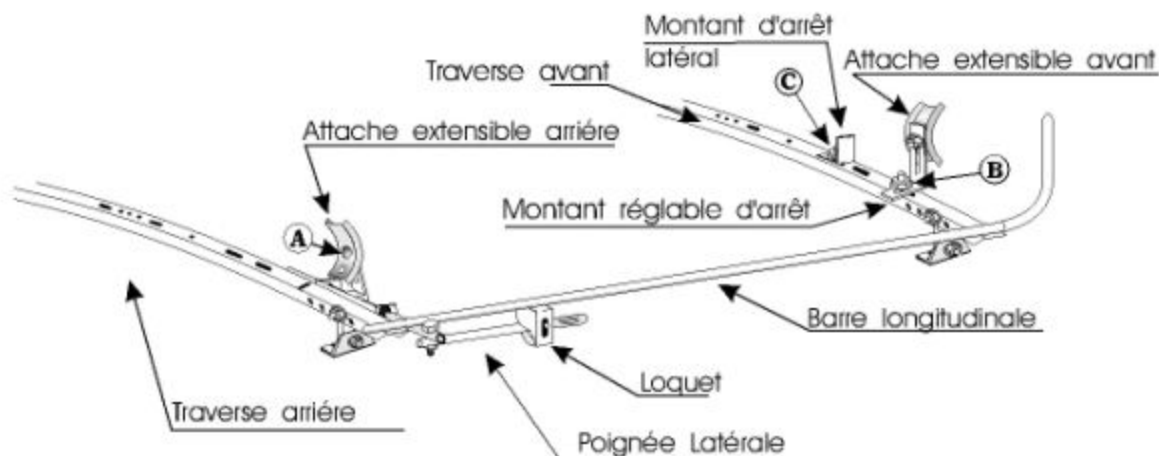

Note à l'installateur:

S.V.P. mettre cette page d'instructions pour l'ajustement du support dans le camion du client pour qu'il ou elle puisse l'ajuster correctement.

MERCI !

