

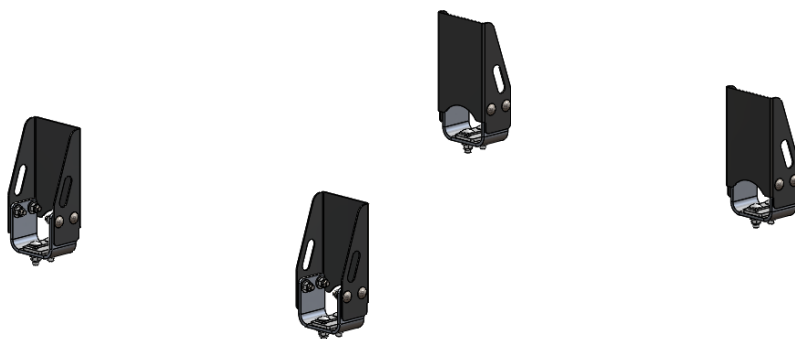

6" Upright Kit, 4-Pack, Black



PRODUCT WEIGHT
9.3 LBS

WIDTH x DEPTH x HEIGHT
3.8" x 2.3" x 6"

CAPACITY
N/A

COLOR
ALL BLACK

CATALOG NUMBER
6UPK4AB

PRODUCT FEATURES

Galvanized steel 6" uprights fully plastisol coated for PROFILE™ HD Utility and combo ladder racks. Works on all vehicle platforms. Works with all conduit kits and rear rollers.

Utility style ladder racks are not recommended for medium and high roof vehicles!

Please refer to OEM specific mounting kit and rail kit for additional information on compatible accessories.

SEE PAGE 2 FOR APPLICATION NOTES AND ACCESSORIES, OTHER PRODUCTS THAT WORK WITH THIS UNIT.

PAGE 1 of 2

The information contained in this document is the sole property of ADRIAN STEEL COMPANY. ADRIAN STEEL COMPANY retains the right to modify and/or change the product of its design at any time without prior notification.



CATALOG NUMBER 6UPK4AB

PRODUCT APPLICATION

This product is for PROFILE™ HD Utility and combo ladder racks. Works on all vehicle platforms. Utility style ladder racks are not recommended for medium or high roof vehicles!

ACCESSORIES THAT WILL WORK WITH THIS PRODUCT

CATALOG NUMBER	DESCRIPTION
2BARB	2-Crossbar Kit, 68", Black, Full Size Van
2BARCB	2-Crossbar Kit, 58", Black, Minivan
1BARB	Single Crossbar Kit, 68", Black, Full Size Van
1BARCB	Single Crossbar Kit, 58", Black, Minivan
2BARTOPB	2-Crossbar Kit, 48", Black, Multiple Pickups
1BARTOPB	Single Crossbar Kit, 48", Black, Multiple Pickups

INSTR. NUMBER : 65319		PG: 1	REV: C	ITEM NO.	PART NUMBER	DESCRIPTION	QTY.
PART NUMBER • 6UPK2B PART NUMBER • 9UPK2B				1	65120-W	UTILITY,UPR MOUNT BRKT,W	2
				2	63848-B	UTILITY, UPRIGHT, 6", B	2
PART • UTILITY,6" UPRIGHT KIT,2B DESC. • UTILITY,9" UPRIGHT KIT,2B				3*	65120-W	UTILITY,UPR MOUNT BRKT,W	2
				4*	64060-B	UTILITY, UPRIGHT, 9", B	2

NOTE: THIS INSTRUCTION IS VALID FOR THE FOLLOWING UPRIGHT KITS:

6UPK2B (SHOWN)

6UPK4B

9UPK2B

9UPK4B

ITEMS NOTED (#*) ARE PART OF 9UPK2B

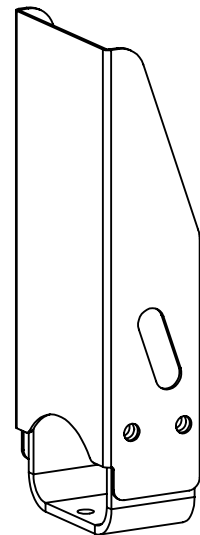
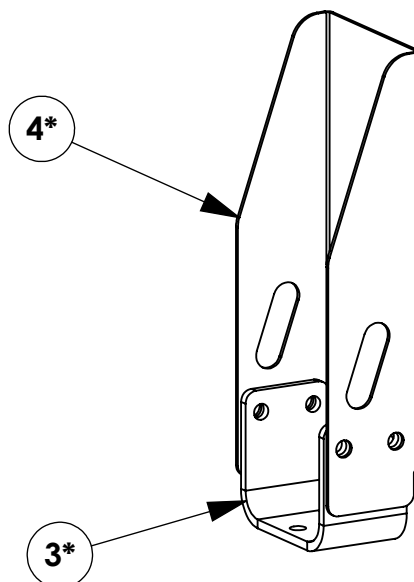
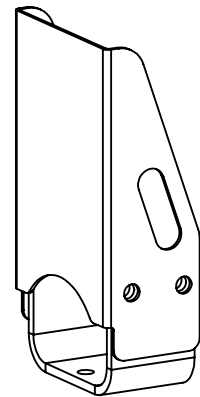
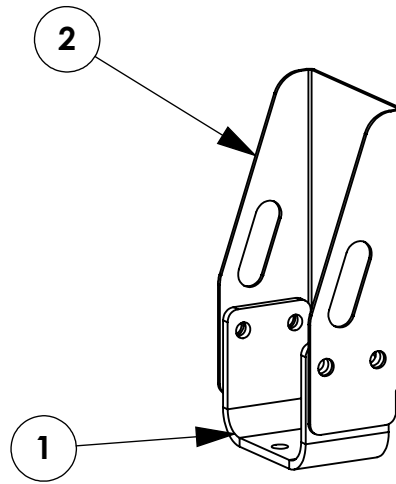

GET TO KNOW THE VEHICLE - AT THE BEGINNING OF ANY INSTALLATION, CHECK THE LOCATION OF THE FUEL TANK, FUEL LINES, BRAKE LINES, HIGH VOLTAGE BATTERIES AND WIRING HARNESSSES TO AVOID INJURY OR PROPERTY DAMAGE FROM TOOL CONTACT.

SEAL ALL EXTERIOR HOLES - ALL INSTALLATION HOLES SHOULD BE SEALED WITH BUTYL TAPE OR SILICON TO PREVENT WATER AND EXHAUST GASES FROM ENTERING THE VEHICLE.

CONTROL DRILL DEPTH - TO AVOID DAMAGE TO THE VEHICLE, USE A DRILL STOP OR CLEARED STEP BIT WHEN DRILLING INSTALLATION HOLES.

ALWAYS ADD PRIMER - WHEN ADDING INSTALLATION HOLES BE SURE TO USE A SELF-ETCHING PRIMER TO PREVENT CORROSION, FASTENER FAILURE AND INJURY.

MOUNTING POINTS MUST HAVE METAL-TO-METAL CONTACT - USE PROVIDED MOUNTING SPACERS TO ACCOMMODATE FOR VEHICLE FEATURES, CARPET OR SUBFLOORS.

PROVIDE CLEARANCE FOR SPACERS - IF THE INSTALLATION VEHICLE CONTAINS A CARPET OR SUBFLOOR, USE A 1-3/16" DIAMETER CARPET CUTTER (P/N: 31183-0) AT ALL MOUNTING LOCATIONS TO OPEN UP ROOM FOR SPACERS.

CHECK SPACER ORIENTATION - BE SURE THAT THE INDENT IN THE SPACER COVERS THE PLUSNUT HEAD; THIS ENSURES THE MOST METAL-TO-METAL CONTACT AND REDUCES VIBRATION.

PLUSNUT INSTALLATION - A PLUSNUT GUN IS RECOMMENDED FOR PLUSNUT INSTALLATION FOR ITS PRODUCTION SPEED. HOWEVER, A PLUSNUT SETTING TOOL CAN ALSO BE USED (P/N: 22200-0).

THRU-BOLT CLEARANCE - WHEN USING A THRU-BOLT AT ANY MOUNTING LOCATION, BE SURE THAT YOUR HOLE HAS 1/16" CLEARANCE.

FASTENERS USED

**QUANTITIES ARE LISTED FOR 6UPK2B / 9UPK2B.
QUANTITIES WILL VARY BASED ON NUMBER OF UPRIGHTS**

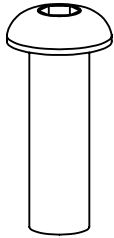

FAS0813
5/16-18x1.0 SS
BHCS SCREW
QTY: 8

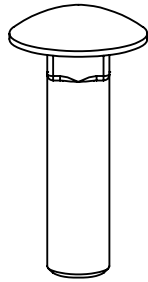

FAS0812
5/16-18x1.25 SS
CRG BOLT
QTY: 4



FAS0552
5/16 SS
FLAT WASHER
QTY: 12

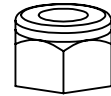

FAS0248
5/16-18 SS
NLK HEX NUT
QTY: 12

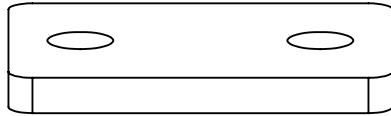

63933
UTILITY,
SPACER
QTY: 2

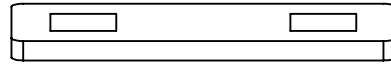

63934
UTILITY,
BOLT PLATE
QTY: 2

BEGIN ASSEMBLY
STEP 1 - ASSEMBLE UPRIGHTS

FAS0813, (2) FAS0552,
AND FAS0248
(4 PLACES PER UPRIGHT)
3/16 HEX DRIVE
1/2 SOCKET

DRILL HOLES IN UPRIGHT
WITH 11/32" DRILL BIT
BEFORE ASSEMBLING!
(4 PLACES PER UPRIGHT)

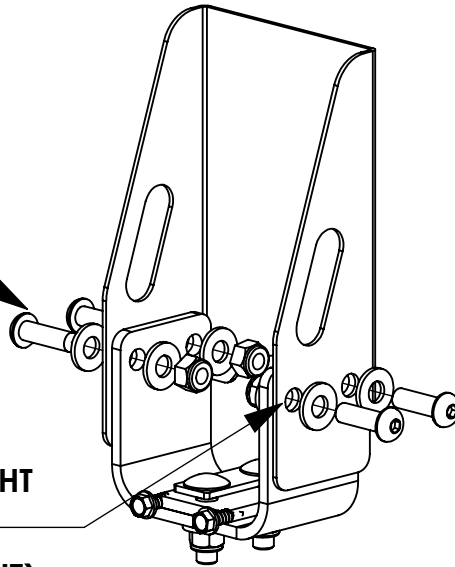

BEGIN INSTALLATION
STEP 2 - INSTALL UPRIGHTS

(2) FAS0812, (2) FAS0552,
63933, 63934, & (2) FAS0248
(PER UPRIGHT)
1/2 SOCKET

ALIGN UPRIGHT WITH
EDGE OF CROSSBOW

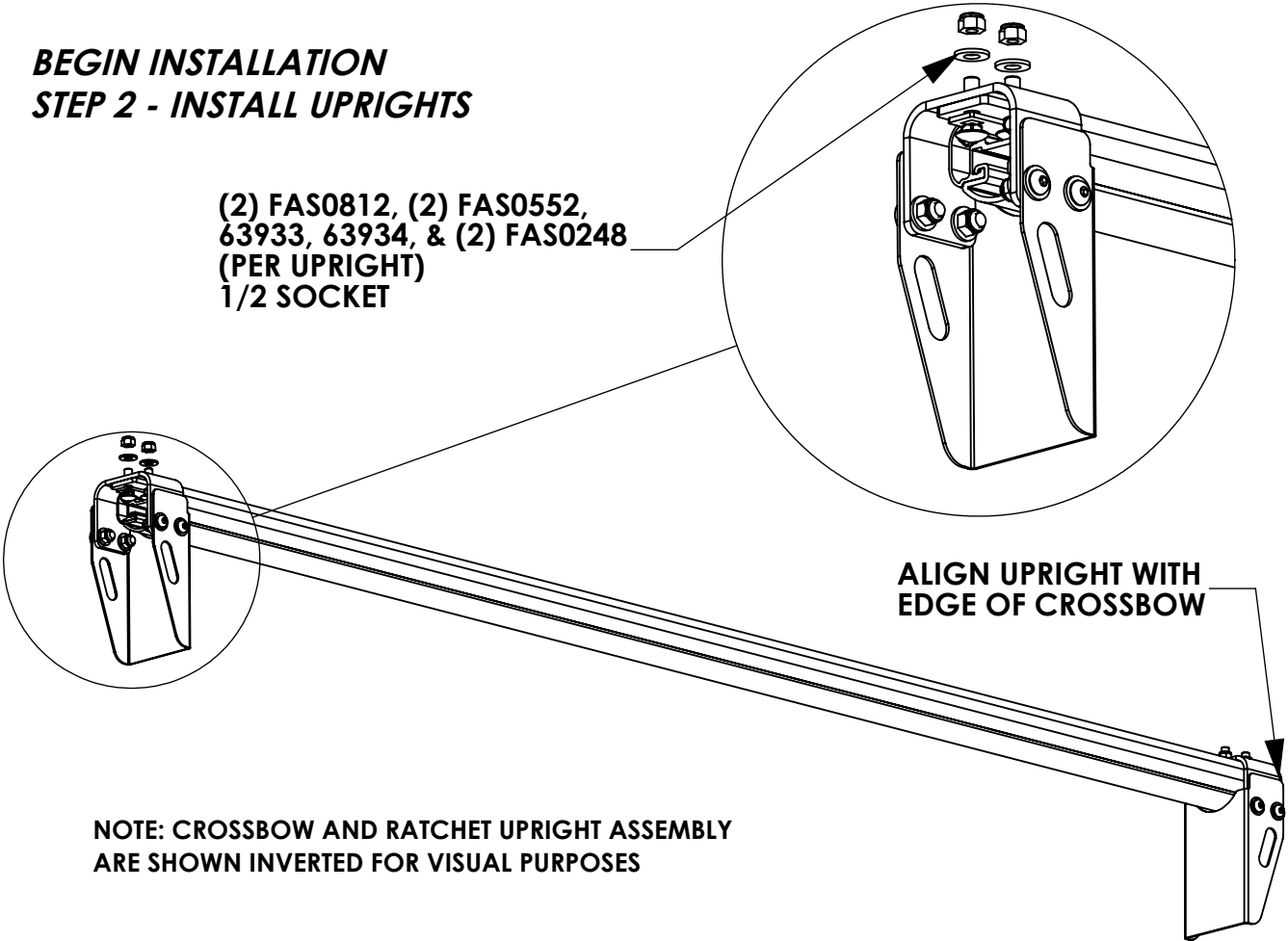

NOTE: CROSSBOW AND RATCHET UPRIGHT ASSEMBLY
ARE SHOWN INVERTED FOR VISUAL PURPOSES

CONTINUE WITH INSTALLATION WITH THE MOUNTING KIT INSTRUCTIONS