

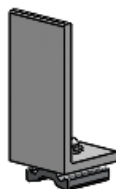

4" Upright Kit, 2-Pack, Black

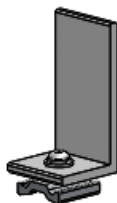

PRODUCT WEIGHT
1.8 LBS

WIDTH x DEPTH x HEIGHT
2" x 2" x 4"

CAPACITY
N/A

COLOR
ALL BLACK

CATALOG NUMBER
4UPK2AB

PRODUCT FEATURES

Aluminum 4" uprights with plastisol coating for PROFILE™ HD Utility and combo ladder racks. Works on all vehicle platforms. Works with all conduit kits and rear rollers.

Utility style ladder racks are not recommended for medium and high roof vehicles!

Please refer to OEM specific mounting kit and rail kit for additional information on compatible accessories.

SEE PAGE 2 FOR APPLICATION NOTES AND ACCESSORIES, OTHER PRODUCTS THAT WORK WITH THIS UNIT.



CATALOG NUMBER 4UPK2AB

PRODUCT APPLICATION

This product is for PROFILE™ HD Utility and combo ladder racks. Works on all vehicle platforms. Utility style ladder racks are not recommended for medium or high roof vehicles!

ACCESSORIES THAT WILL WORK WITH THIS PRODUCT

CATALOG NUMBER	DESCRIPTION
2BARB	2-Crossbar Kit, 68", Black, Full Size Van
2BARCB	2-Crossbar Kit, 58", Black, Minivan
1BARB	Single Crossbar Kit, 68", Black, Full Size Van
1BARCB	Single Crossbar Kit, 58", Black, Minivan
2BARTOPB	2-Crossbar Kit, 48", Black, Multiple Pickups
1BARTOPB	Single Crossbar Kit, 48", Black, Multiple Pickups

<i>INSTR. NUMBER</i> : 65318 <i>PART NUMBER</i> • 4UPK2B <i>PART NUMBER</i> • 4UPK4B	<i>PG:</i> 1	<i>REV:</i> A	ITEM NO.	PART NUMBER	DESCRIPTION	QTY.
			1	65138-B	UTILITY, UPRIGHT, 4", B	2
<i>PART</i> • UTILITY,4" UPRIGHT KIT,2B <i>DESC.</i> • UTILITY,4" UPRIGHT KIT,4B						

NOTE: THIS INSTRUCTION IS VALID FOR ANY COMBINATION OF 4UPK4B/4UPK2B

4UPK2B IS SHOWN THROUGHOUT INSTRUCTION

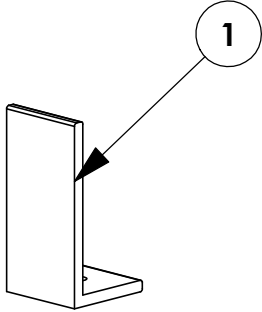
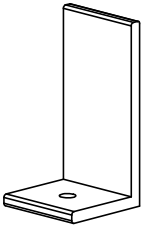

GET TO KNOW THE VEHICLE - AT THE BEGINNING OF ANY INSTALLATION, CHECK THE LOCATION OF THE FUEL TANK, FUEL LINES, BRAKE LINES, HIGH VOLTAGE BATTERIES AND WIRING HARNESSSES TO AVOID INJURY OR PROPERTY DAMAGE FROM TOOL CONTACT.

SEAL ALL EXTERIOR HOLES - ALL INSTALLATION HOLES SHOULD BE SEALED WITH BUTYL TAPE OR SILICON TO PREVENT WATER AND EXHAUST GASES FROM ENTERING THE VEHICLE.

CONTROL DRILL DEPTH - TO AVOID DAMAGE TO THE VEHICLE, USE A DRILL STOP OR CLEARED STEP BIT WHEN DRILLING INSTALLATION HOLES.

ALWAYS ADD PRIMER - WHEN ADDING INSTALLATION HOLES BE SURE TO USE A SELF-ETCHING PRIMER TO PREVENT CORROSION, FASTENER FAILURE AND INJURY.

MOUNTING POINTS MUST HAVE METAL-TO-METAL CONTACT - USE PROVIDED MOUNTING SPACERS TO ACCOMMODATE FOR VEHICLE FEATURES, CARPET OR SUBFLOORS.

PROVIDE CLEARANCE FOR SPACERS - IF THE INSTALLATION VEHICLE CONTAINS A CARPET OR SUBFLOOR, USE A 1-3/16" DIAMETER CARPET CUTTER (P/N: 31183-0) AT ALL MOUNTING LOCATIONS TO OPEN UP ROOM FOR SPACERS.

CHECK SPACER ORIENTATION - BE SURE THAT THE INDENT IN THE SPACER COVERS THE PLUSNUT HEAD; THIS ENSURES THE MOST METAL-TO-METAL CONTACT AND REDUCES VIBRATION.

PLUSNUT INSTALLATION - A PLUSNUT GUN IS RECOMMENDED FOR PLUSNUT INSTALLATION FOR ITS PRODUCTION SPEED. HOWEVER, A PLUSNUT SETTING TOOL CAN ALSO BE USED (P/N: 22200-0).

THRU-BOLT CLEARANCE - WHEN USING A THRU-BOLT AT ANY MOUNTING LOCATION, BE SURE THAT YOUR HOLE HAS 1/16" CLEARANCE.

FASTENERS USED

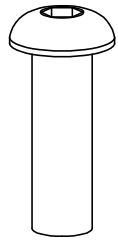

FAS0813
5/16-18X1.0 SS
BHCS SCREW
QTY: 2



FAS0588
5/16 SS
SPLIT WASHER
QTY: 2

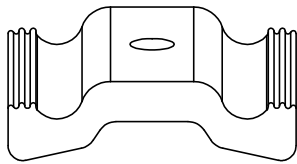

35335-0
1.5" SLIDE
AD RAIL
QTY: 2



FAS0552
5/16 SS
FLAT WASHER
QTY: 2

**BEGIN ASSEMBLY
STEP 1 - CUT WEAR STRIP**

**REMOVE 2 INCHES FROM WEAR STRIP PER
SIDE THAT WILL HAVE UPRIGHT INSTALLED**

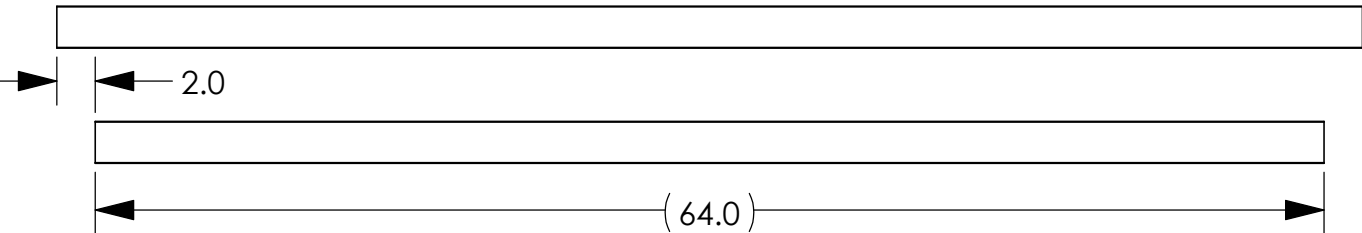

**ADD ONE OF THE CUT WEAR STRIPS TO EACH
CROSSBOW. CENTER WEAR STRIP ON CROSSBOW**

**FOR RACKS THAT ONLY GET UPRIGHTS ON ONE SIDE, CUT
WEAR STRIP TO 66 INCHES. ALIGN END OF WEAR STRIP WITH
END OF CROSSBOW THAT WILL NOT HAVE UPRIGHT INSTALLED**

**BEGIN INSTALLATION
STEP 2 - INSTALL UPRIGHTS**

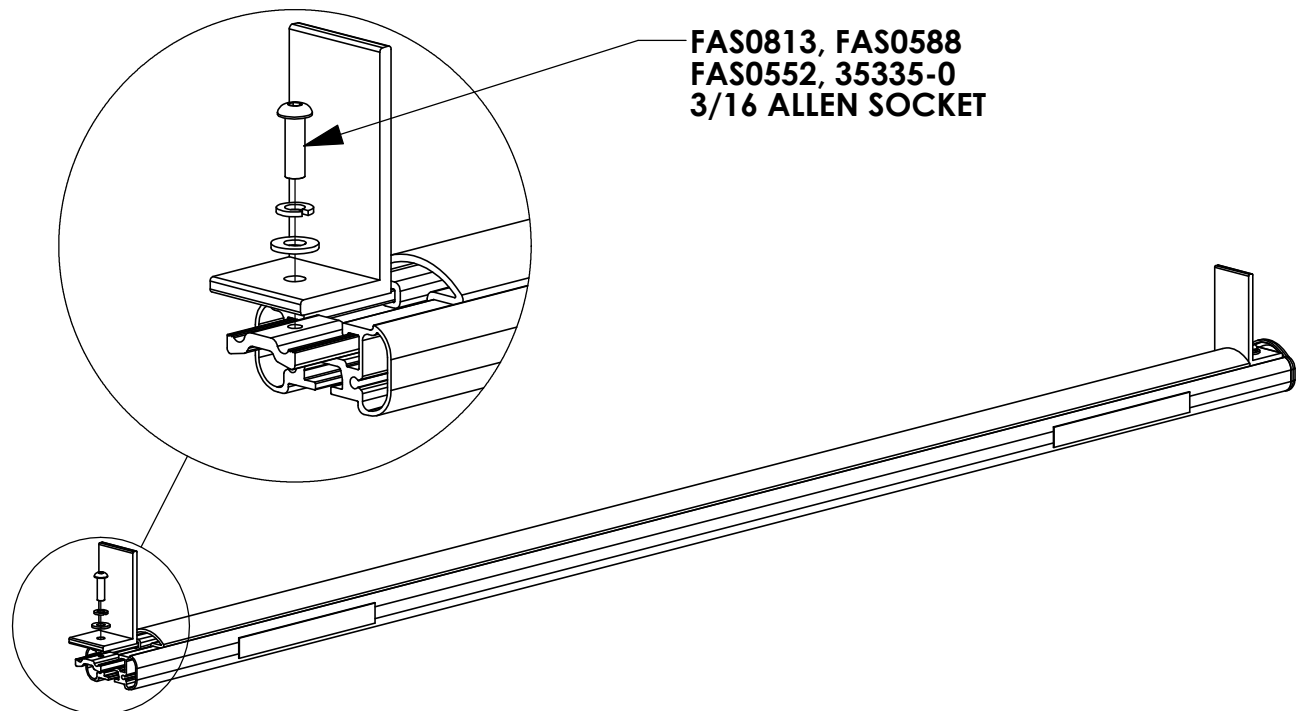

CONTINUE INSTALLATION WITH THE MOUNTING KIT INSTRUCTIONS